

## Conception de la spirale d'or :

→ Une spirale d'or est constituée de quart de cercle dont chaque rayon est proportionnel au rayon suivant dans un rapport égal du nombre d'or.

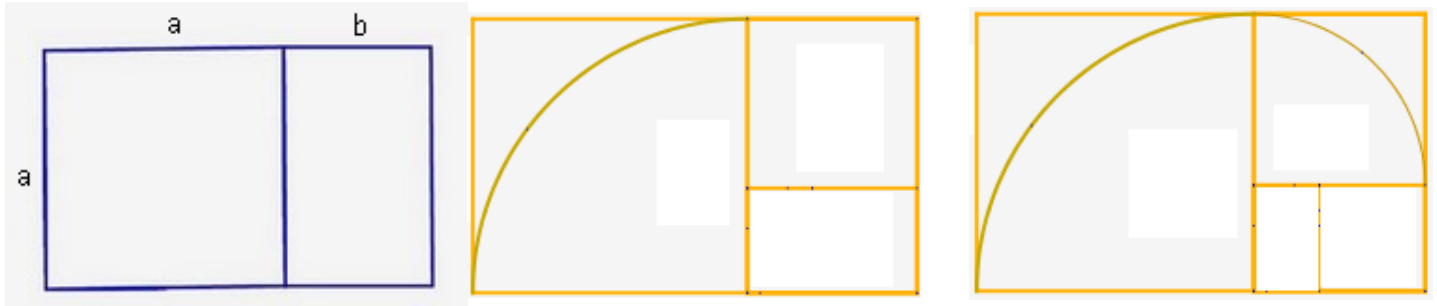

On obtient la spirale d'or ci dessous

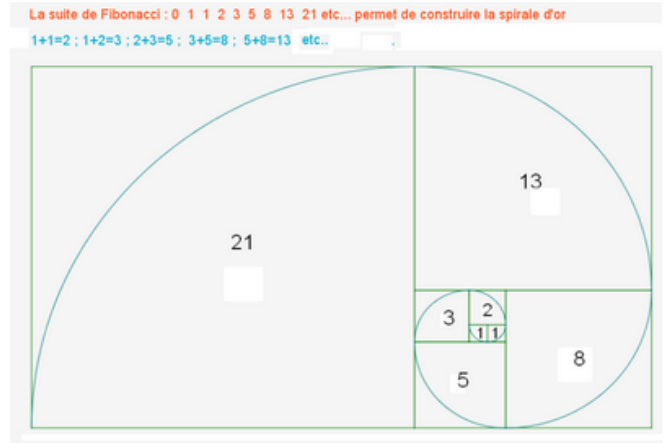
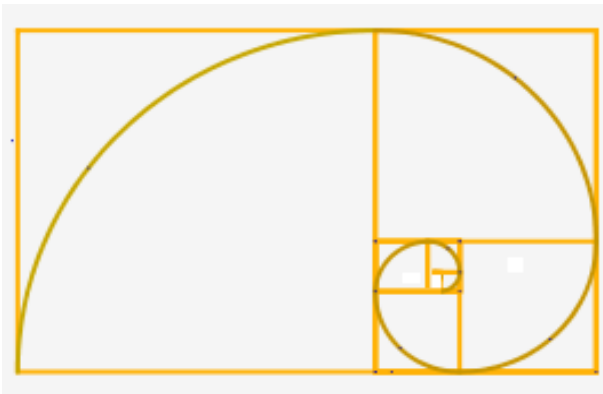

**Conception de la spirale d'argent :** même méthode que pour la spirale d'or.

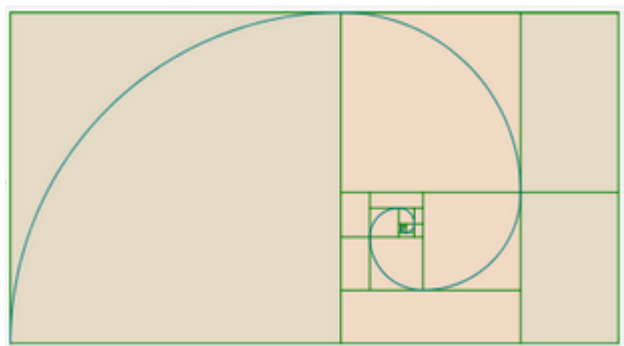
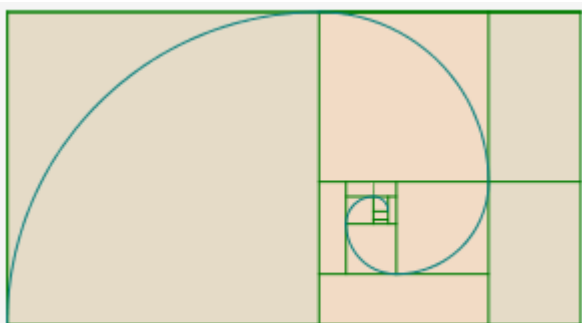
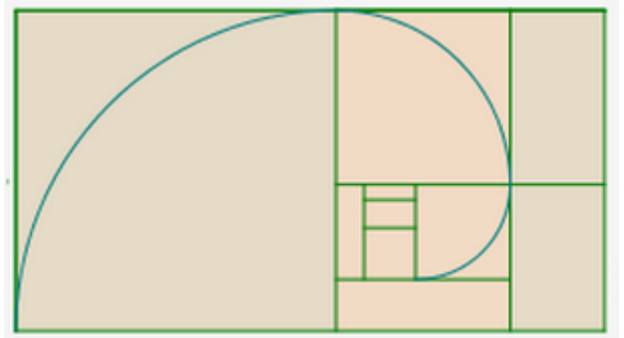
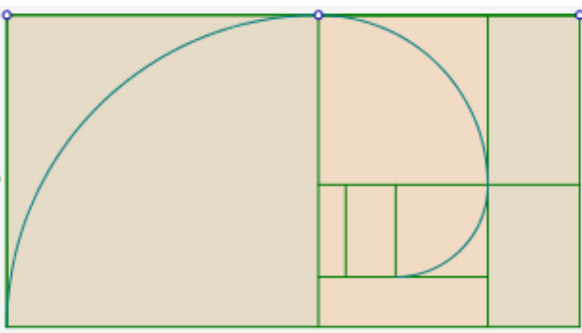
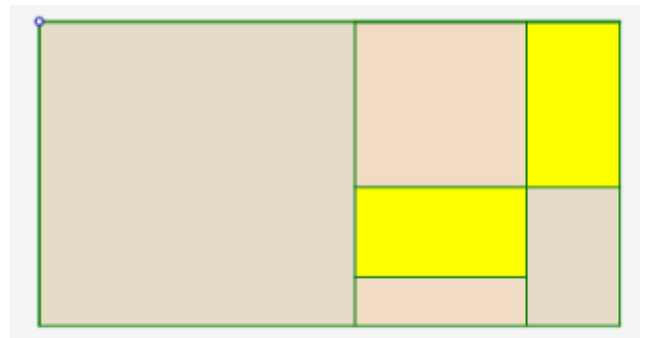
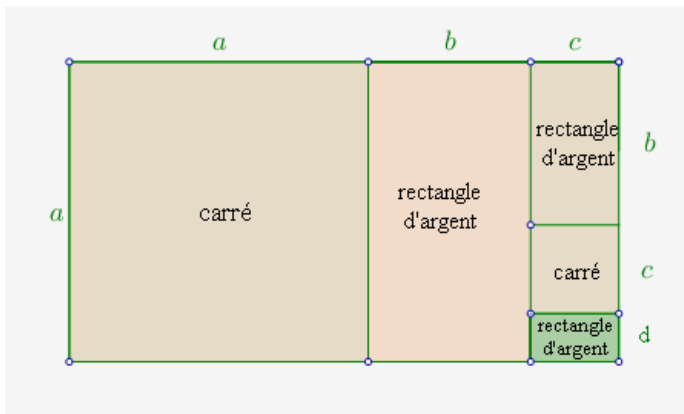

## Conception de la spirale de cuivre

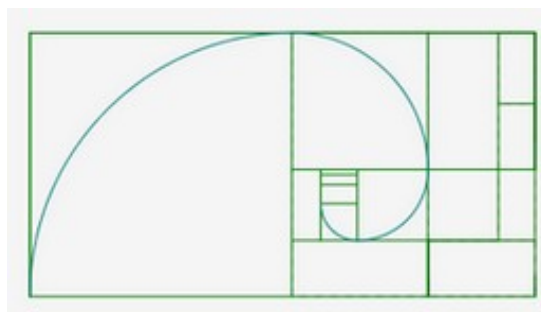
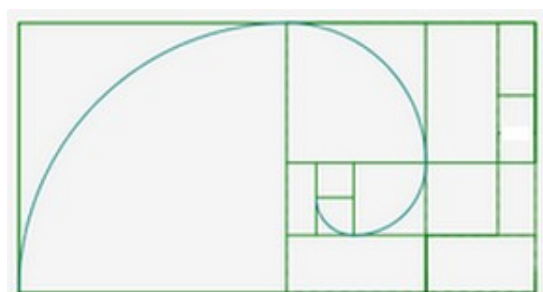
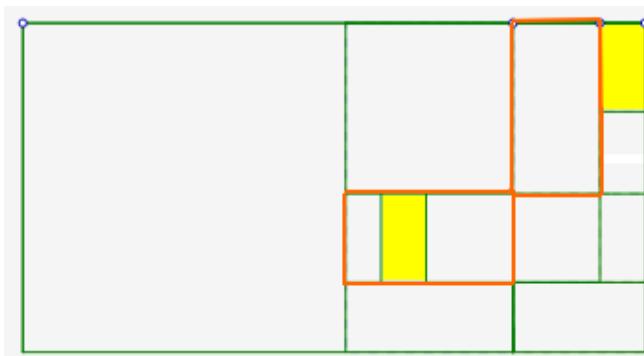

On a tracé les 4 arcs de cercle, on recommence le procédé avec le petit rectangle de cuivre (figure ci dessus à droite)

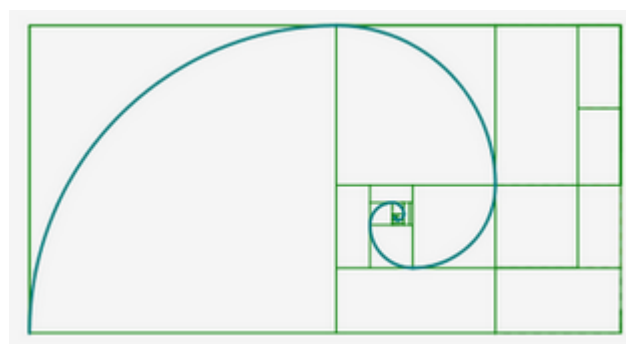
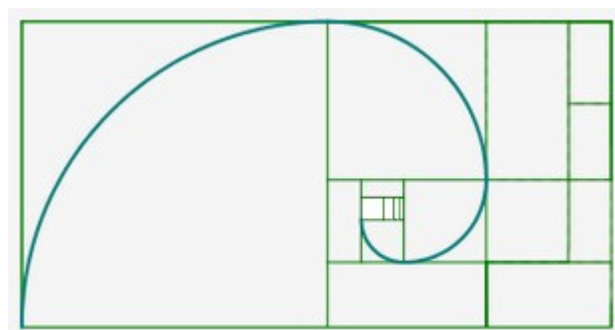

## Trilogie de spirales métalliques

*spirale d'or*

*spirale d'argent*

*spirale de cuivre*

